

Model 43AP Pneumatic Controller, Style B

Installation and Operation

Model 43AP Controller continuously detects the difference between a process measurement and its set point, and produces an output air signal that is a function of this difference and the type of control. The output signal is transmitted to a control valve or other control device. The process measurement, set point, and output signal are indicated on the controller.

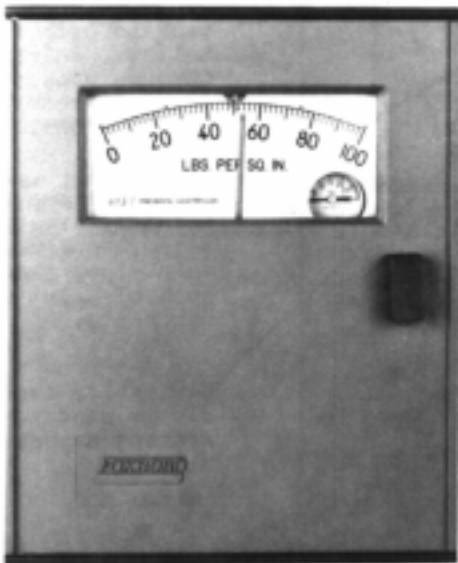

Standard Specifications

Types of Control

Suffix Code –A1:	On-Off
A2:	Proportional
A3:	Proportional plus Derivative
A4:	Proportional plus Reset
A5:	Proportional plus Reset plus Derivative
A7:	Differential Gap
A8:	Automatic Shutdown

Control Limits

Proportional:	4 to 400%
Reset:	0.01 to 50 minutes per repeat
Derivative:	0.05 to 50 minutes
Differential Gap:	1 to 100%

Output Signal:	3-15 psi or 20-100 kPa
Air Supply:	20 psi (140 kPa)
Air Consumption:	0.3 std ft ³ /min (0.5 std m ³ /h)
Air Connections:	Tapped for 1/4 NPT
Ambient Temperature Limits:	–40 to +180°F (–40 to +80°C)
Weight:	Approx. 10 lb (4.5 kg), excluding element
Case:	Glass fiber reinforced plastic

Principle of Operation

1. A differential linkage measures difference between measurement pointer and setting index positions. This error signal moves proportioning lever.
2. Proportioning lever pivots at its center on end of a flat spring.
3. This motion changes flapper nozzle relationship, causing relay to establish an output pressure.
4. Output pressure is fed back to proportioning bellows, which acts through proportioning lever to rebalance flapper nozzle.
5. Reset bellows and tank assembly are used when measurement must be maintained exactly at control point (without “offset”).
6. Derivative tank assembly is used to improve system response to a slow process.

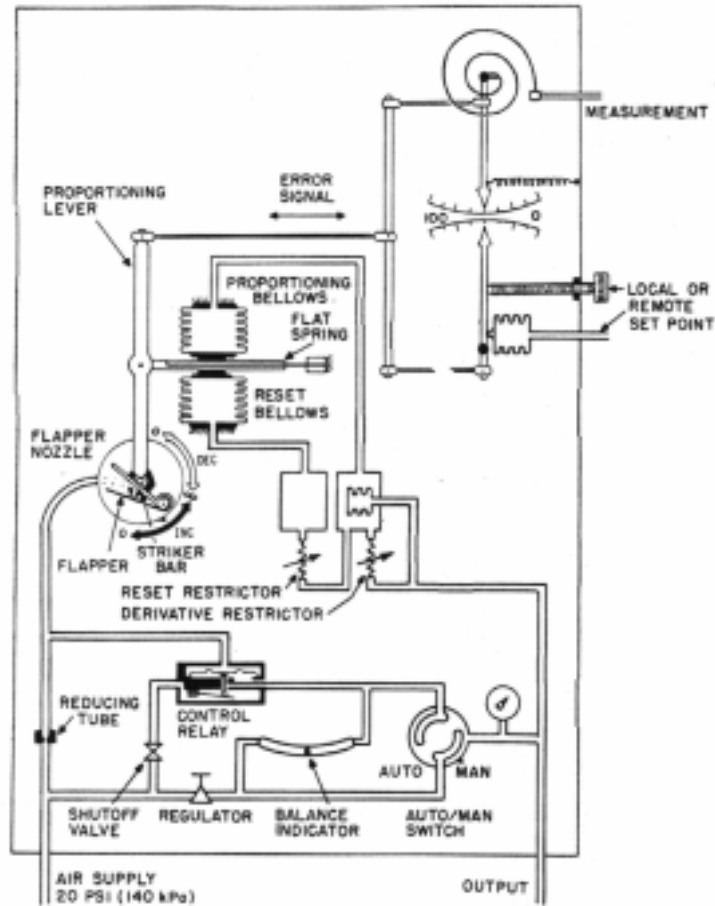

Controller with Proportional, Reset, and Derivative Actions, and Automatic-Manual Transfer System (Optional)

Proportional Control

For description, see Items 1 through 4 above.

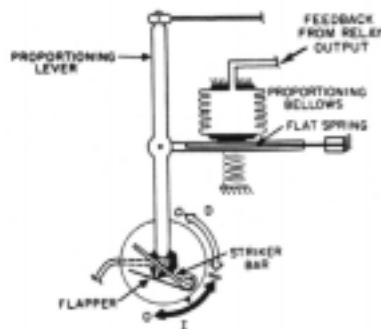

On-Off Control

On-off control is obtained by pivoting the proportional lever about a fixed point without proportioning or reset bellows. This controller can be equipped with an automatic shutdown unit.

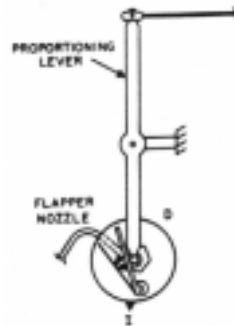

Differential Gap Control

Differential gap control is obtained with positive feedback..

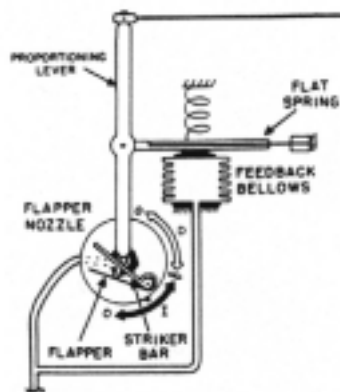

Installation

Controller Mounting

Mount controller level on a rigid support. If controller has Type 37 Meter, see page 8.

Flush Mounting

After case is inserted in panel, install mounting brackets as shown. Slide brackets firmly against panel and tighten bracket bolts to case.

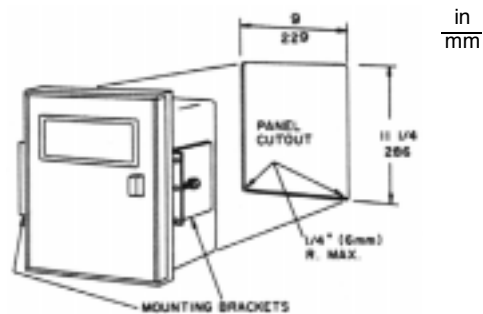

Surface Mounting

Loosely install mounting brackets flush with rear of case as shown. Attach brackets to panel with 1/4-inch bolts or #14 wood screws. Tighten mounting bracket bolts to case.

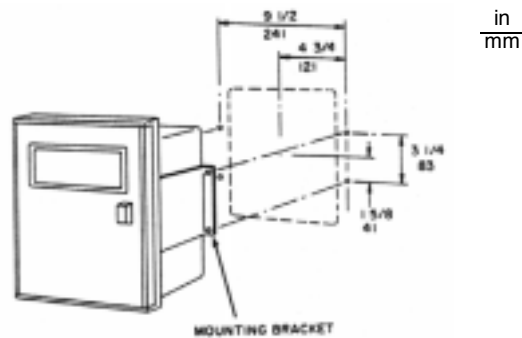

Pipe Mounting

Remove mounting bracket from controller case. Securely fasten bracket on a 2-inch or 3-inch pipe. Then reinstall controller into bracket.

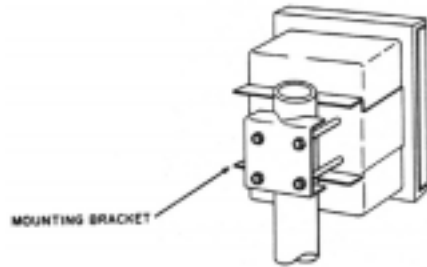

Controller Dimensions and Connections

Flush Mounting

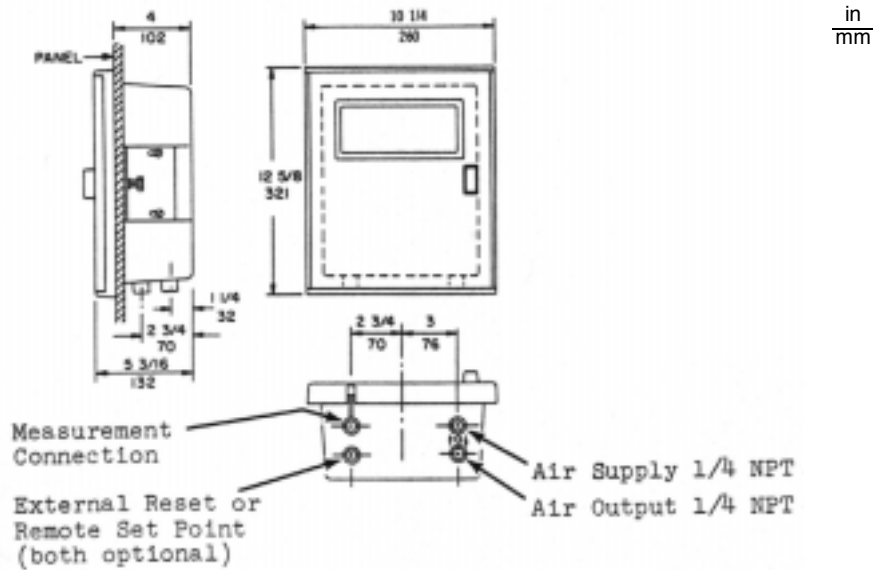

Surface Mounting

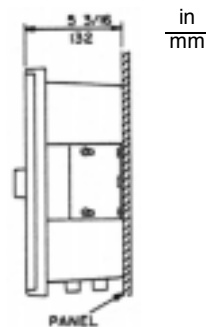

Pipe Mounting

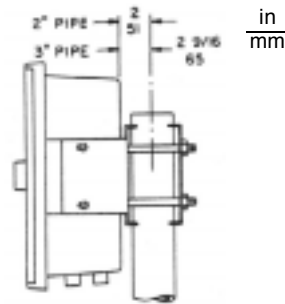

Pressure Connection

- 1/4 NPT female (up to 2000 psi or 14 MPa)
- 1/2 NPT male (above 2000 psi or 14 MPa)
- 9/16-18 Aminco (from 10000 psi or 70 MPa)

Pneumatic Receiver Connection

- 1/4 compression fitting

— NOTE —

When installing piping, hold case connections stationary with wrench.

Optional Integral Filter-Regulator Set

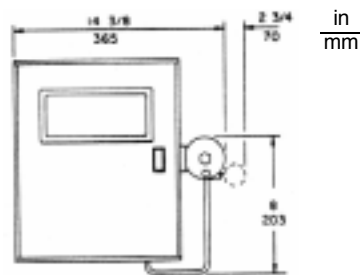

Air Supply and Output Piping

For Control Valve Piping see Instruction MI 012-210.

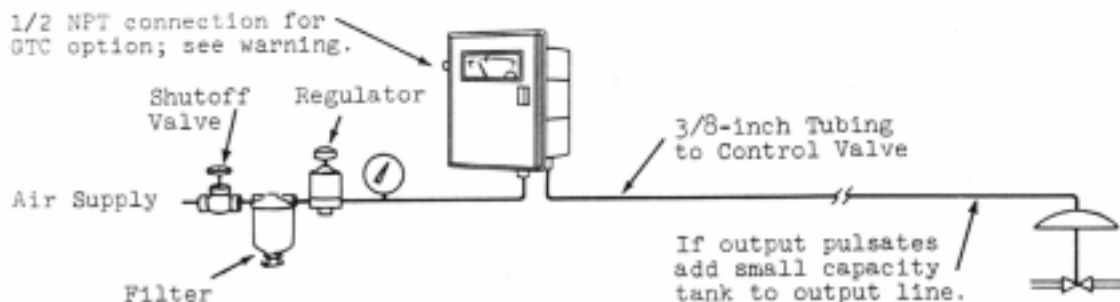

! WARNING

Air is usually used as controller operating gas, and it is vented directly from case. If a hazardous¹ gas is to be used instead, "GTC" option must be specified. This option provides a vent connection on case which can be used to pipe gas to a location classified for its dispersal. In addition, in normal operation some gas may bleed from case; therefore, classification of controller location must permit presence of this gas.

1. Air supply must be regulated at 20 psi (140 kPa).
2. Controller uses about 0.3 std ft³/min (0.5 std m³/h) of air in normal operation.
3. Air must be clean and dry. Blow out filter regularly.
4. Air lines must be free of leaks.

Mounting Controller with Type 37 Meter

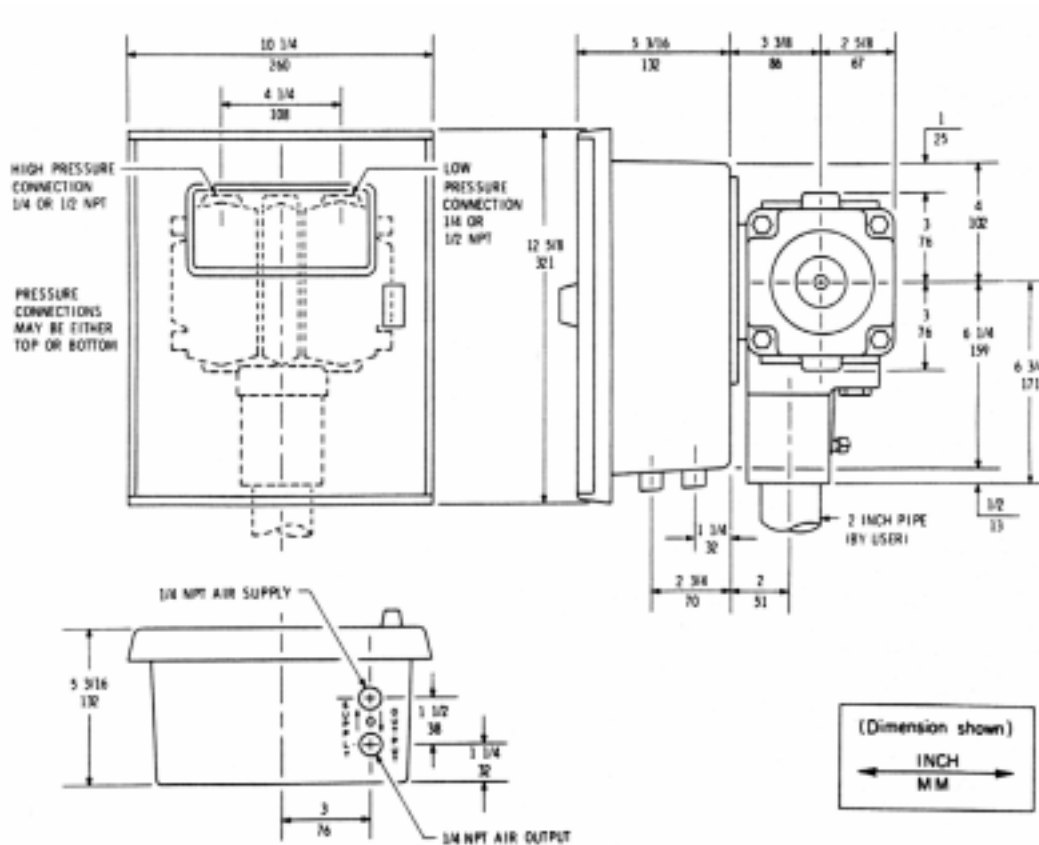

1. See Nat'l Elect'l Code, NFPA 70, Art. 500-517.

Automatic-Manual Transfer System (optional)

The automatic-manual transfer system consists of a regulator, a sensitive balance indicator, and a transfer switch. The system permits switching between manual and automatic control without upsetting the process.

The illustration below shows the components that are concerned with the transfer system.

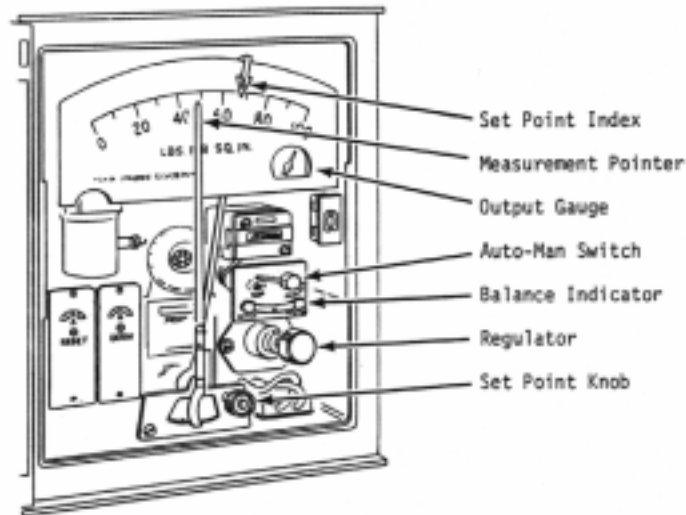

To Transfer from Manual to Automatic Control

Slowly turn set point knob (or adjust remote set point, if present) to move balance indicator ball to within central portion of tube (not up against either end). Then turn switch to automatic (A).

To Transfer from Automatic to Manual Control

Turn regulator slowly to move balance indicator ball to within central portion of tube (not up against either end). Turn regulator so that top of knob moves in direction that ball is to move. Then turn switch to manual (M). Valve can now be controlled with regulator.

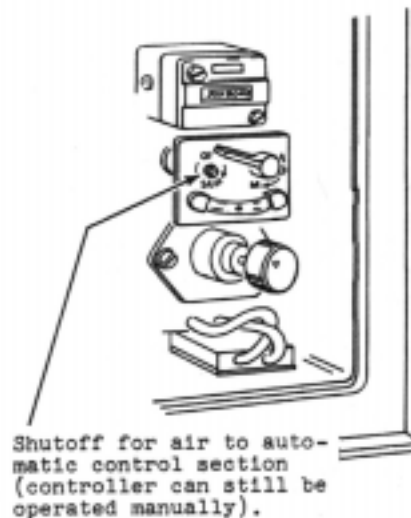

Automatic-Manual Transfer Using 2-Position Nozzle Seal Switch (optional)

In place of the transfer system above, a 2-position nozzle seal switch is available. Moving this switch to the manual (M) position, seals the nozzle line causing the output to increase to the supply pressure. The output can now be set to the desired value by reducing the pressure with an external supply regulator furnished by the user.

To Transfer from Manual to Automatic Control

Turn set point knob (or adjust remote set point, if present) so that set point index is in line with measurement pointer. Move switch to automatic (A). Quickly increase air supply pressure to 20 psi (140 kPa).

To Transfer from Automatic to Manual Operation

Slowly reduce air supply pressure to output pressure, and move switch to manual (M). Valve can now be controlled with regulator.

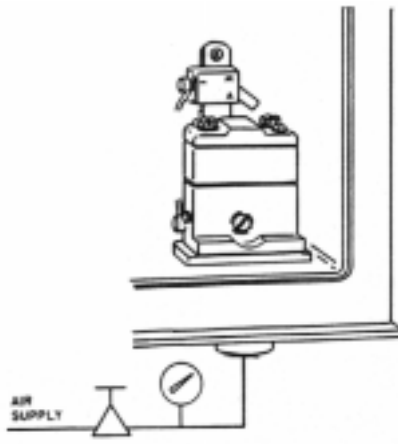

Putting Into Operation

For on-off, differential gap, or automatic shutdown controllers, see page 14.

1. Make sure that measuring system is properly installed and operating.
2. Set control dial so that index points to desired control action (output either increases or decreases with increasing measurement).

With latch in lowered position (as shown below), control dial cannot be accidentally rotated to area of reverse control action.

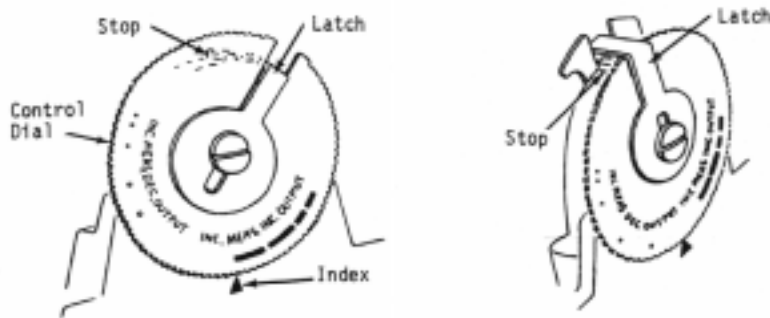

To reverse control action, push up latch and rotate dial so that latch is on other side of stop, then push down latch (see figure below).

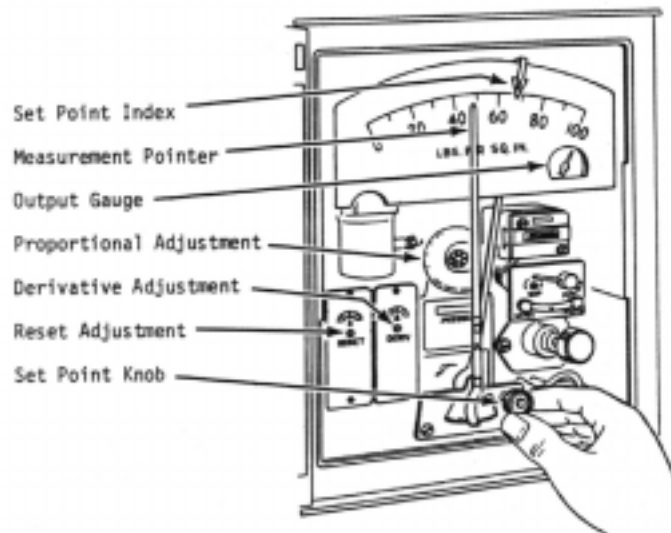

3. Turn PROPORTIONAL BAND adjustment (on control dial) to 400 or to safe high value.

Turn DERIVATIVE adjustment (if present) to 0.05.

Turn RESET adjustment (if present) to 50 or safe high value.

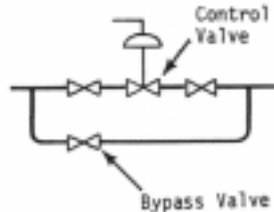

4. Open shutoff valves and close bypass valve.
5. Turn set point knob (or adjust remote set point, if present) so that set point index is at desired value.
6. If controller is not equipped with optional automatic-manual transfer, proceed to Step 7. If controller is equipped with transfer, start up in manual as follows:
 - a. Move transfer switch to manual (see page 9).
 - b. Turn on 20 psi (140 kPa) air supply. Blow out filter.
 - c. Adjust output with regulator so that measurement pointer is held as close as possible to set point index.
 - d. After measurement has stabilized, move transfer switch to automatic (see transfer procedure on page 9). Process is now on automatic control.
7. If controller is not equipped with optional automatic-manual switch, turn on 20 psi (140 kPa) air supply. Blow out filter.
8. After measurement has stabilized, adjust proportional band, derivative, and reset controls (if present) for best process operation (see page 13).
9. With reset control, after process has stabilized with proper control settings, if set point index and measurement pointer do not coincide, adjust as follows:
 - a. Loosen lock screw.
 - b. Adjust nylon eccentric to change index. Retighten lock screw.

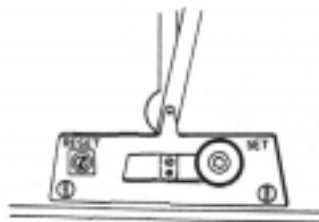

Control Adjustments

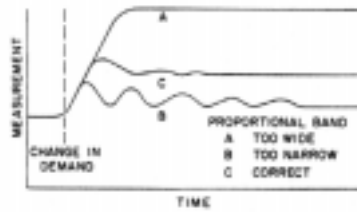

Effect of Various Proportional Band Settings

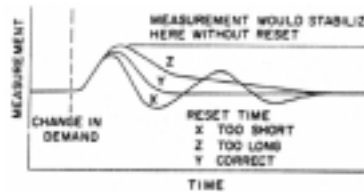

Effect of Various Reset Times

Proportional Controller (Model 43AP-A2)

1. Set PROPORTIONAL BAND at 400 or at safe high value.
2. Make change in set point. Observe process and output responses.
3. If cycling does not occur, adjust PROPORTIONAL BAND to half of previous value.
4. Repeat Steps 2 and 3 until cycling is observed. Then increase PROPORTIONAL BAND to twice its value.

Proportional Plus Derivative Controller (Model 43AP-A3)

1. With DERIVATIVE at 0.05, adjust PROPORTIONAL BAND as described in Proportional Controller, above.
2. Adjust DERIVATIVE using same procedure as Proportional Band, except doubling each setting instead of halving it.

Proportional Plus Reset Controller (Model 43AP-A4)

1. With RESET at 50 or at safe high value, adjust PROPORTIONAL BAND as described in Proportional Controller, above.
2. Adjust RESET using same procedure as Proportional Band.

Proportional Plus Reset Plus Derivative Controller (Model 43AP-A5)

1. With RESET at 50 or at safe high value, and DERIVATIVE to 0.05, adjust PROPORTIONAL BAND as described in Proportional Controller, above.

2. Adjust DERIVATIVE using same procedure as Proportional Band, except doubling each setting instead of halving it.
3. Adjust RESET to final setting of Derivative in Step 2, above.

On-Off and Automatic Shutdown Controllers

As the measurement crosses the control point (determined by the setting index), the control valve fully opens (or closes), and as the measurement reverses and recrosses the control point, the control valve fully closes (or opens).

1. Rotate control dial so that arrow points to small rectangle of desired control action.
2. After process has stabilized, if setting index and measurement pointer do not coincide, adjust index as shown on top of Page 7 of Instruction MI 011-477.

— NOTE

For operation details of automatic shutdown unit, see Instruction MI 011-484.

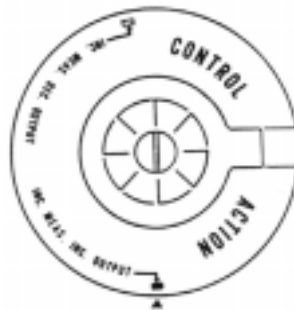

Differential Gap Action Controller

As the measurement goes below the lower control point, the control valve fully opens (or closes). This reverses the measurement but there is no change in control action until the measurement crosses the upper control point, at which time the valve fully closes (or opens). One control point is determined by the setting index and the other control point by the gap width (see example below).

Gap width = difference between control points divided by span.

For example, if measurement scale is graduated from 20 to 120, and control points are to be 70 and 90, gap width

$$= \frac{90 - 70}{120 - 20} = 20\%$$

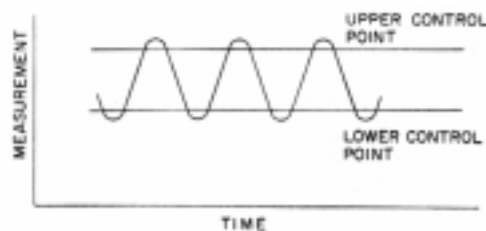

Typical Differential Gap Action Control Record

1. If “Increasing measurement, INCREASING output” section of control dial is used, turn set point knob (or adjust remote set point, if present) to bring index to LOWER control point.

If “Increasing measurement, DECREASING output” is used, bring index to UPPER control point.

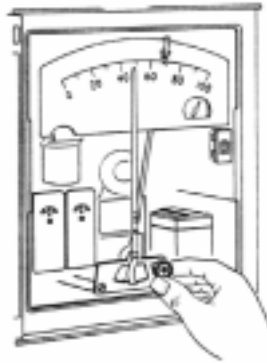

2. Rotate control dial so that arrow points to desired gap width with desired control action.

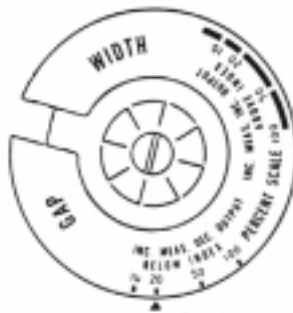

3. When measurement pointer (moving within gap) coincides with setting index, output (on output gauge) should change suddenly. If this change does not occur when the two are in line, adjust index as shown on bottom of Page 7 of Instruction MI 011-477.

ISSUE DATES

JAN 1980

Vertical lines to right of text or illustrations indicate areas changed at last issue date.

The Foxboro Company
33 Commercial Street
Foxboro, MA 02035-2099
United States of America
<http://www.foxboro.com>
Inside U.S.: 1-888-FOXBORO
(1-888-369-2676)
Outside U.S.: Contact your
local Foxboro Representative.
Facsimile: (508) 549-4492

Foxboro is a registered trademark of The Foxboro Company.
Siebe is a registered trademark of Siebe, plc.
Aminco is a trademark of American Instrument Co.

Copyright 1980 by The Foxboro Company
All rights reserved